

Data Sheet



Article number: 20302357

Description: E+G Handwheel
DIN 950-AL-500-B34-A

Measures

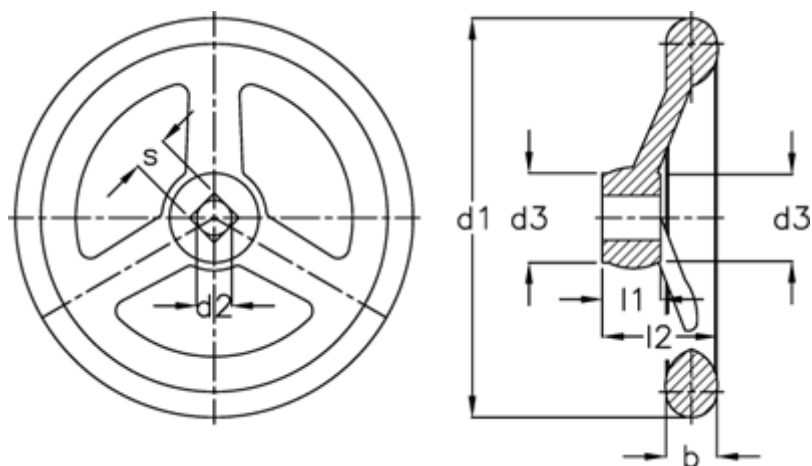

b	= 34
d1	= 500
d2 H7	= 34
d3	= 78
l1	= 45
l2	= 72
Number of spokes	= 5